

1T7036 | OZ Recessed profile

Recessed profile for 25x25mm light modules

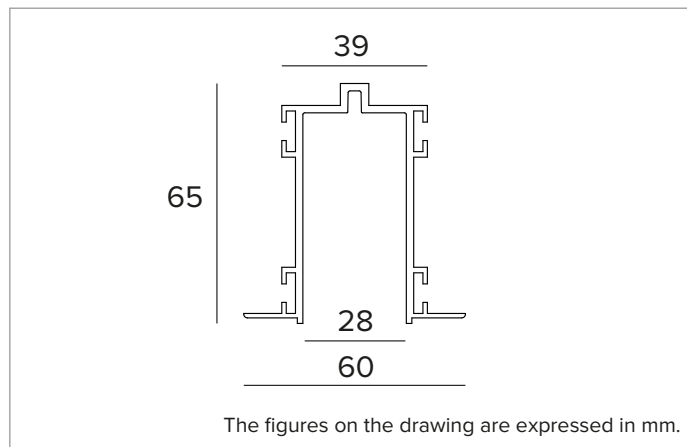
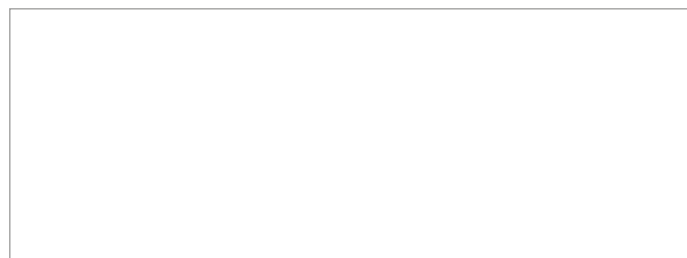

MECHANICAL CHARACTERISTICS

Extruded painted aluminium profile.

Colour and finish: Deep black

Dimensions: L=3000mm

Weight: 3.34Kg

Version: FOR 25x25mm LIGHT MODULES

INSTALLATION

For trimless installation or with a flange.

NOTES

To be completed with Power Track.

WARRANTY

5 years.

WARNING

Luminaire designed for disposal/recycling at end-of-life.

Due to the technological evolution of the electronic components, the data provided may be updated, and as such, confirmation must be requested during the order process.

Luminous flux and power supply have +/-10% tolerances with respect to the indicated value. tq +25°C (CIE 121).

We reserve the right to make technical changes.

Targetti Sankey S.r.l.
Via Pratese, 164
50145 Firenze - Italy
Tel: +39 055 37911
targetti.com
targetti@targetti.com

CCIAA Firenze
Share Capital:
€ 500.000,00
VAT N. (IT):
01537660480
R.E.A.: FI-275656

TARGETTI

1T7036 | OZ Recessed profile

Recessed profile for 25x25mm light modules

Related codes

Mounting System

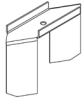

Code

1T7043

Steel bracket for recessed installation of the small profile.
2 pieces to be ordered for 1m long modules, 3 pieces for 2m long modules and 4 pieces for 3m long modules.

End Caps

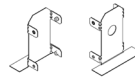

Colour

Code

**1T7040**

Kit containing 2 profile end caps.
For small recessed profiles.

Accessories

Mechanical connector

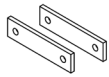

Code

1T7041

Kit composed of 2 mechanical linear joints and 4 thrust screws.
For trimless installation profile.



Colour

Code

**1T7038**

Mechanical L connector.
For small recessed profiles.

Due to the technological evolution of the electronic components, the data provided may be updated, and as such, confirmation must be requested during the order process.

Luminous flux and power supply have +/-10% tolerances with respect to the indicated value. tq +25°C (CIE 121).

We reserve the right to make technical changes.

Targetti Sankey S.r.l.
Via Pratese, 164
50145 Firenze - Italy
Tel: +39 055 37911
targetti.com
targetti@targetti.com

CCIAA Firenze
Share Capital:
€ 500.000,00
VAT N. (IT):
01537660480
R.E.A: FI-275656

TARGETTI